

HENRIKSEN HOOKS

HOOKS
HENRIKSEN HOOKS

HMKG

OFF-LOAD RELEASE MANUAL HOOKS



U
S
E
R

M
A
N
U
A
L

Rev.: A-

M000133

HENRIKSEN

REDUCING OPERATIONAL RISK

Phone: +47 33 37 84 00
hooks@hhenriksen.com
www.henriksenhooks.com

GENERAL

- Read this user manual carefully before you use the hook and save it for future reference.
- Operational scenarios with corresponding risk evaluations must be well known for the operators.
- It is important that the hook is inspected and maintained periodically to ensure a safe and well-functioning equipment.
- Monthly controls by the operators are limited to visual check and practical operations.
- All necessary service and maintenance shall be carried out by authorized service personal annually and by 5-years controls. On-line annual inspection course for Henriksen hooks is available on the internet, please check our website for more information.
- Contact the manufacturer in case of any visible damage and/or if malfunction occurs.
- Any unauthorized repair, service and/or parts used in the hook will violate the warranty.



HMKG

LAUNCH

- 1 Check visually the following before launch:
 - the hook is not damaged
 - the hook element is in closed position
 - the handle is in the low (closed) position
 - the safety pin is properly placed, refer to the illustration
 - the lifting ring is properly placed
 - the hook is free of any impurities or ice

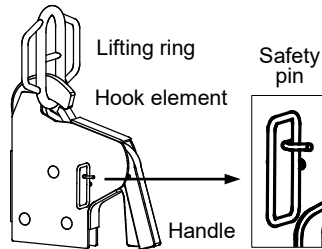

- 2 Start the lowering process with a continuous motion.

- 3 While the boat is lowered down, twist the safety pin clockwise and pull it out.

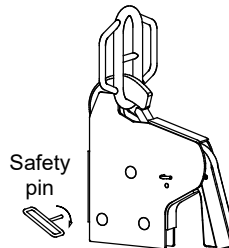

L
A
U
N
C
H

HENRIKSEN HOOKS



HMKG

LAUNCH

- 4** When the boat is close to the water surface, compress the handle lever and set the handle to the high (activated) position.

Stand back and take a safe stand-by position.

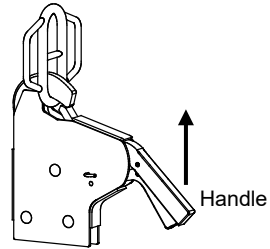

- 5** When the boat gets waterborne and the hook is off-loaded, the hook will open automatically and release the lifting ring.

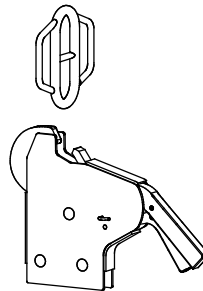

L
A
U
N
C
H



HMKG

RESET

- 1 Compress the handle lever and set the handle to the low (closed) position.

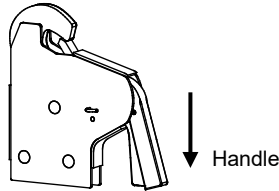

- 2 Insert the safety pin.
Make sure that the safety pin is properly placed, refer to the illustration.

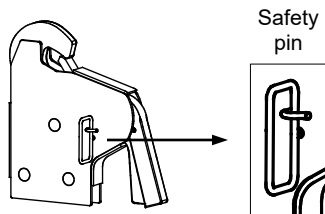

RECOVERY

- 1 Check visually that the hook is not damaged.
Make sure that the hook is reset.
Place the lifting ring properly into the jaw of the hook.

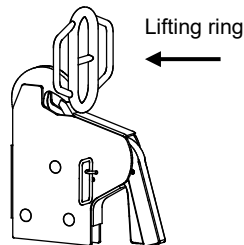

- 2 Make sure that the latch is completely locked, refer to the illustration.
The hook is ready to recover the boat.

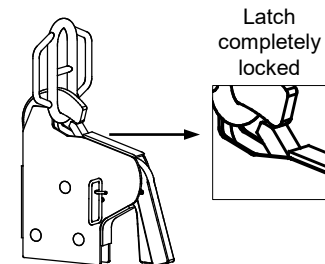

NOTE: See the “SAFE USE” chapter at the end of the manual for the recommended lifting operations.

HMKG

GENERAL CONSIDERATIONS

- 1 Consider the position of the hook before mounting it on the boat. The hook shall be placed over the center of gravity. The load going through it shall be as straight and symmetrical as possible during the **whole** lifting operation.

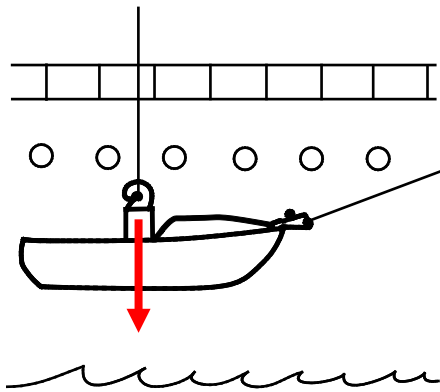

- 2 Make sure that the hook operator can get access to the hook easily and can operate the hook and connect the lifting ring safely.
- 3 Consider prevention against impurities and icing on the hook.
- 4 We strongly recommend to use standard Henriksen Lifting Rings, because the ring dimensions are designed to **geometrically fit** together with the Henriksen Hooks. See more details in our **HLR** document.
- 5 We offer standard Henriksen Bolt Sets and Shims for mounting. See more details in our **Bolt Set** and **Shims** documents.

HMKG

RECOMMENDED BOLTS AND LOCKNUTS

Hook type	SWL (kg)	Bolts and locknuts ⁽¹⁾ dimensions (minimum A4 70 quality)		Max. torque (Nm)
		to frame ⁽²⁾	to swivel joint	
HMKG 3,5	3 500	M24	M24 x 75	70
HMKGD 3,5	3 500	M24	M24 x 75	70
HMKG 5	5 000	M30	M30 x 90	70
HMKG 8	8 000	M30	M30 x 90	70
HMKG 12	12 000	M30	M30 x 150	70
HMKG 15	15 000	Ø40/M36 ⁽³⁾	Ø40/M36 x 75 ⁽⁴⁾	70

(1) Locknuts according to DIN 985 – Nylon insert.

(2) The bolt should be unthreaded in the lifting cross-section. Use washers with the locknuts if necessary.

(3) Stud bolt: shaft Ø40 with M36 threaded ends, EN 1.4462 quality. Bolts can be ordered from Henriksen, the length is specified by the boat builder.

(4) Stud bolt: shaft Ø40 with M36 threaded ends, EN 1.4462 quality. Shaft length: 75 mm, total length: 163 mm.



HMKG

DIMENSIONS

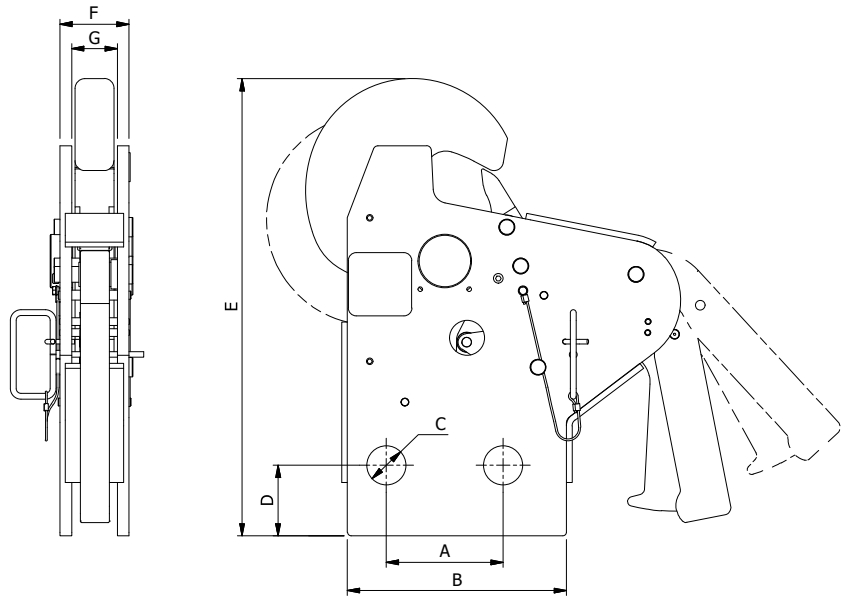

PART NO.	HOOK	SWL	A	B	C	D	E	F	G	WEIGHT
HH003050	HMKG 3,5	3 500 kg	100	180	Ø24,5	49	352	40	30	11,7 kg
HH003879	HMKGD 3,5	3 500 kg	80	150	Ø24,2	40	296	39	29	7,5 kg
HH006180	HMKG 5	5 000 kg	120	225	Ø30,5	60	439	47	35	22,1 kg
HH006192	HMKG 8	8 000 kg	120	225	Ø30,5	60	439	51	35	25,2 kg
HH000048	HMKG 12	12 000 kg	100	180	Ø30,5	40	350	80	50	33,5 kg
HH000050	HMKG 15	15 000 kg	120	225	Ø40,5	73	470	71	47	35,4 kg

NOTE: Detailed drawings and 3D models are available on request.

HMKG

- 1** Place the hook between the plates of the lifting arrangement of the boat.

We recommend:

- to use two outside mounting plates if possible
- to apply shims to reduce the gap between the mounting plates and the hook.

Check that the handle points in the preferred direction.

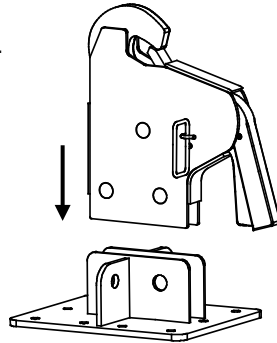

- 2** Insert the mounting bolts through the holes on the lifting arrangement and the hook.

WARNING:

Use only recommended bolt, see the table on page 6.

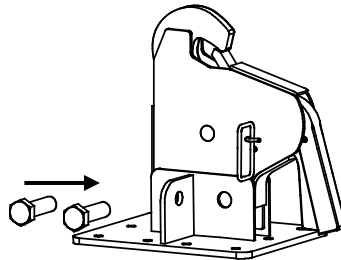

- 3** Mount the locknuts.

We recommend to hold the hook in lifted position when tightening the nuts.

WARNING:

Use only recommended locknuts and torques, see the table on page 6.

Always use new locknuts.

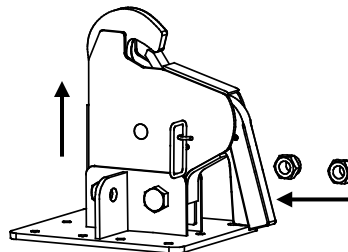

HMKG

FUNCTIONAL TEST

Do a functional test of the following after mounting the hook on the boat:

- The handle can be set to high and low positions.
- The hook element can open fully.
- The ring shall be inserted simply and safely.
- The safety pin shall be inserted and pulled out easily.
- The hook is loaded as straight and symmetrical as possible during the **whole** lifting operation.



HMKG

1 For safety reasons carry out the control in good lighting conditions.



2 Remove all impurities (salt, grease, dust, etc.) with fresh water. Remove ice if necessary.



3 Check that the following parts are free from deformations and defects:

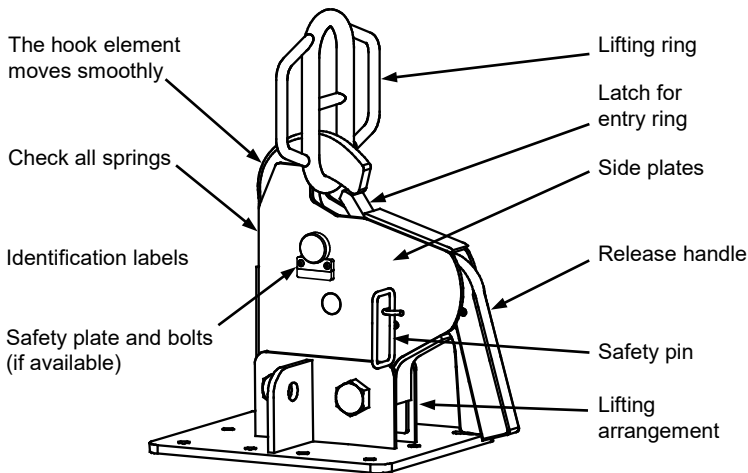

Contact the manufacturer in case of any deviation!

HMKG

- 4** Do a functional test of the following:
- The handle can be set to high and low positions.
 - The hook element can open fully.
 - The ring shall be inserted simply and safely.
 - The safety pin shall be inserted and pulled out easily.
 - The hook is loaded as straight and symmetrical as possible during the **whole** lifting operation.

5 DO NOT PAINT ANY PART OF THE HOOK!



Contact the manufacturer in case of any deviation!



HMKG

SAFE LAUNCH

1 The hook operator connects the lifting ring and the painter line before launch, and then gives a signal to the crane operator that the lowering process can start.

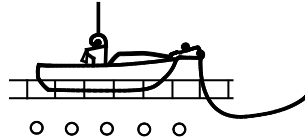

2 The crane operator starts the lowering process with a continuous motion.

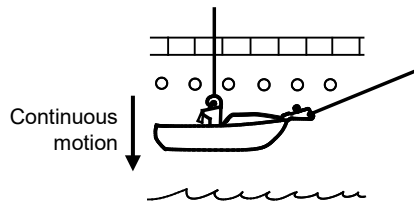

3 The operators make sure that there are no obstacles under the boat.

The hook operator then activates the lifting hook when the boat is close to the water surface.

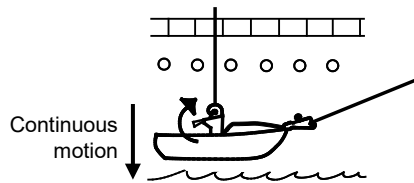

4 The hook operator stands back and takes a safe stand-by position.

S
A
F
E

U
S
E

HMKG

SAFE LAUNCH

- 5** When the boat gets waterborne and the lifting hook is off-loaded, the hook will open automatically and release the lifting ring.

The crane operator lifts the lifting ring to avoid collision with the boat or the crew.

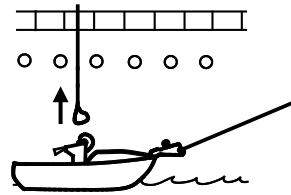

- 6** The coxswain or the hook operator releases the painter line when the boat and the crew are ready.

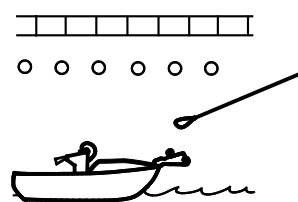

- 7** The coxswain maneuvers the boat ahead and away from the vessel.

S
A
F
E

U
S
E



HMKG

SAFE RECOVERY

1 The hook operator makes sure that both the lifting hook and the painter hook are reset.

2 The coxswain maneuvers the boat close to the vessel to let the hook operator safely get the painter line.

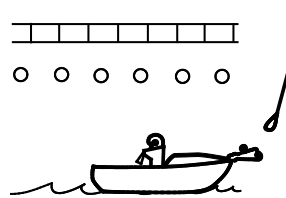

3 The hook operator connects the painter line. The coxswain aligns the direction of the boat to the direction of the vessel.

4 The coxswain reduces the speed of the boat and the painter line is tensioned. The coxswain then makes sure to keep the correct direction of the boat and tension in the painter line.

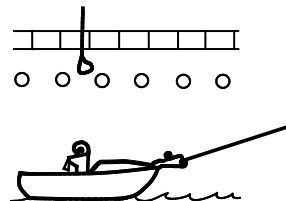

The boat shall then be in the correct position below the lifting ring.

5 The crane operator lowers the lifting ring to let the hook operator safely get it.

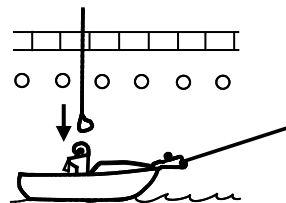

S
A
F
E

U
S
E



HMKG

SAFE RECOVERY

6 The hook operator connects the lifting ring and gives a signal to the crane operator.

The crane operator starts the automatic tensioning system (if available) to give tension in the wire.

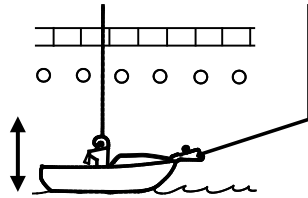

7 The hook operator stands back and takes a safe stand-by position.

8 The crane operator starts the lifting process with a smooth motion as the boat moves upwards on a wave.

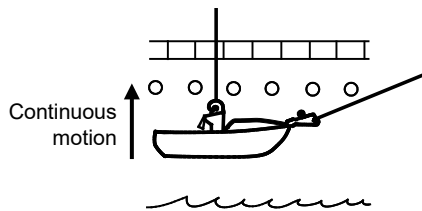

9 The crane operator completes the lifting process with a continuous motion and places the boat into the crib.

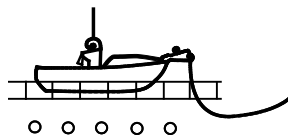

SAFE USE