

HENRIKSEN HOOKS

**HOOKS**  
HENRIKSEN HOOKS

# HCH(T) CRANE HOOKS



U  
S  
E  
R  
  
M  
A  
N  
U  
A  
L

Rev.: B3

M000142

**HENRIKSEN**

REDUCING OPERATIONAL RISK

Phone: +47 33 37 84 00  
hooks@hhenriksen.com  
www.henriksenhooks.com

## HCH(T)

### GENERAL

- Read this user manual carefully before you use the hook and save it for future reference.
- Operational scenarios with corresponding risk evaluations must be well known for the operators.
- It is important that the hook is inspected and maintained periodically to ensure a safe and well-functioning equipment.
- Monthly controls by the operators are limited to visual check and practical operations.
- All necessary examination and maintenance shall be carried out by authorized service personal.
- Annual inspection course for Henriksen hooks is available online, please check our website for more information.
- 5-years thorough examination and overhaul require authorized service personnel trained according to H. Henriksen AS specific procedures to ensure continued compliance with MED-B and MED-D certification for the hook.

The mandatory 5-years overhaul consist of replacement of load bearing components and recertification according to factory acceptance procedures.

- Any unauthorized repair, service and/or parts used in the hook will violate the certification, safety and warranty.
- Contact the manufacturer in case of any visible damage and/or if malfunction occurs.

## HCH(T)

### LAUNCH

- 1 Check the following before launch:
  - the hook is not damaged
  - the hook is securely attached to the crane wire
  - the reset lever (reset knob at HCH 1,5) is in the closed position
  - the hook element is in closed position
  - the hook is free of any impurities or ice

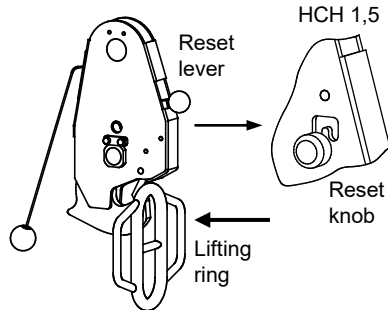

- 2 Place the lifting ring properly into the jaw of the hook.

- 3 Start the lowering process with a continuous motion.

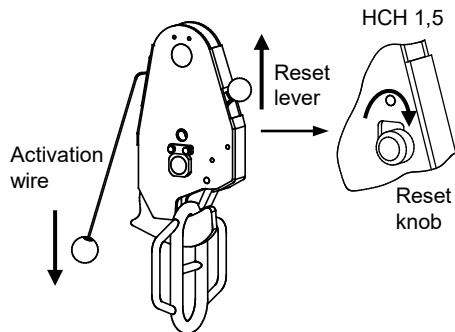

- 4 When the boat is close to the water surface, pull the ball at the end of the activation wire. Make sure that the reset lever (reset knob at HCH 1,5) moves to activated / open position.

- 5 When the boat is waterborne and the hook is off-loaded, the hook will open automatically and release the lifting ring.

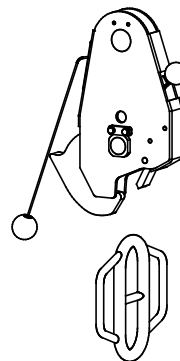

## HCH(T)

### RESET

- 1 Set the reset lever (reset knob at HCH 1,5) to the closed position, confirmed by a click sound.

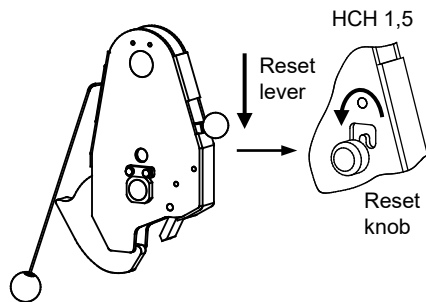

- 2 Set the hook element manually to closed position, confirmed by a click sound.

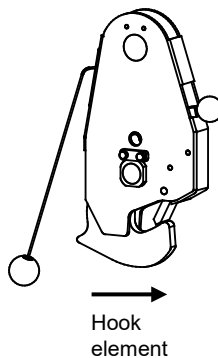

- 3 Make sure that you can clearly see the activation latch in the inspection hole, refer to the illustration.\*

\* HCH 1,5:  
Check that the reset knob is properly in the closed position.

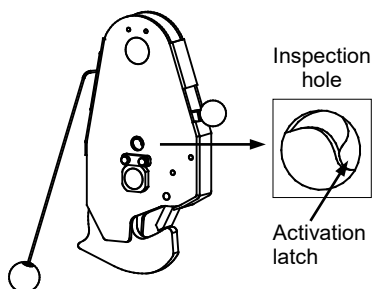

R  
E  
S  
E  
T

## HCH(T)

### RECOVERY

- 1** Check visually that the hook is not damaged.  
Make sure that the hook is reset.  
Place the lifting ring properly into the jaw of the hook.

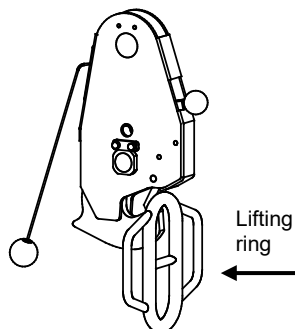

- 2** Make sure that the latch is completely locked, refer to the illustration.  
The hook is ready to recover the boat.

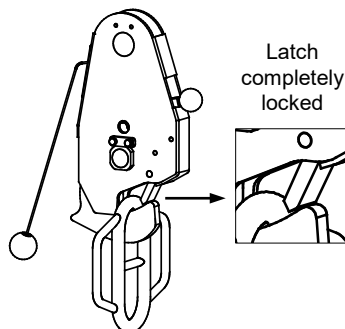

**NOTE:** See the “SAFE USE” chapter at the end of the manual for the recommended lifting operations.

## HCH(T)

### GENERAL CONSIDERATIONS

- 1** We recommend to keep the weight of the crane hook arrangement as low as possible to ensure a lightweight and safe operation environment. Henriksen top attachments are available, such as shackle and thimble.
- 2** We strongly recommend to use standard Henriksen Lifting Rings, because the ring dimensions are designed to **geometrically fit** together with the Henriksen Hooks.

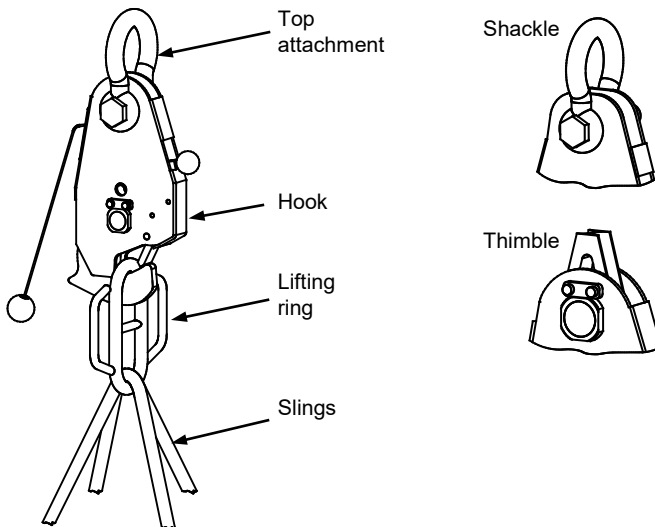

- 3** Consider the operational height and the length of the slings, make sure that the lifting hook operator can get access to the lifting hook easily and can connect the lifting ring safely.
- 4** Consider the risk of injury and/or damage the falling slings may cause when the boat gets waterborne under the launch process.
- 5** Consider prevention against impurities and icing on the hook.



## HCH(T)

### DIMENSIONS

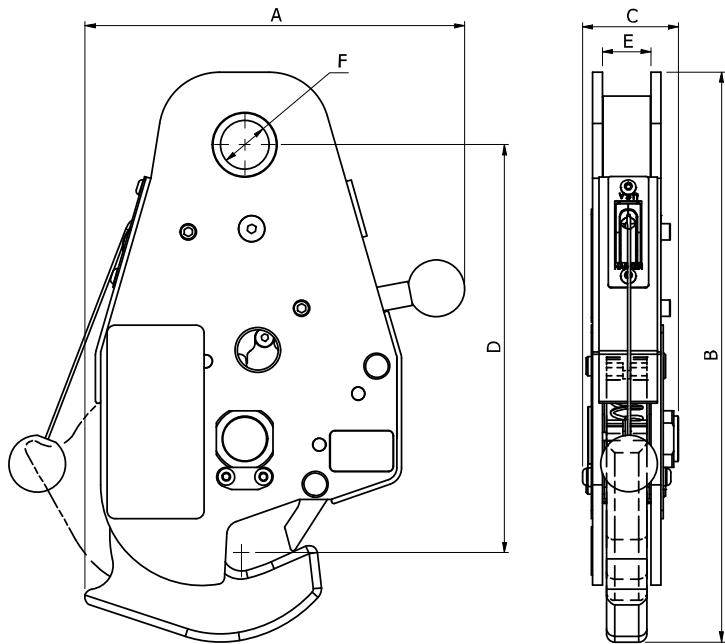

PART NO.	HOOK	SWL	A	B	C	D	E	F	WEIGHT
HH000032	HCH 1,5	1 650 kg	118	235	53	168	20	Ø20	2,22 kg
HH006911	HCHT 3,5	3 500 kg	183	304	50	209	23	Ø31	2,70 kg
HH000094	HCHT 6,5	6 500 kg	235	353	58	253	30	Ø30	5,90 kg
HH003470	HCHT 10	10 000 kg	231	379	78	251	35	Ø40	7,70 kg
HH000331	HCHT 10	10 000 kg	234	379	78	251	35	Ø40	7,70 kg

**NOTE:** Detailed drawings and 3D models are available on request.

## HCH(T)

### FUNCTIONAL TEST

Do a functional test of the following when testing the crane hook arrangement and the lifting arrangement on the boat for the first time:

- The ring shall be inserted simply and safely.  
See the illustration below for correct ring orientation.
- Safe and stable operational conditions for the hook operator
- The hook releases the lifting ring once the boat gets waterborne.

We recommend to prevent the hook against any ice to build up.

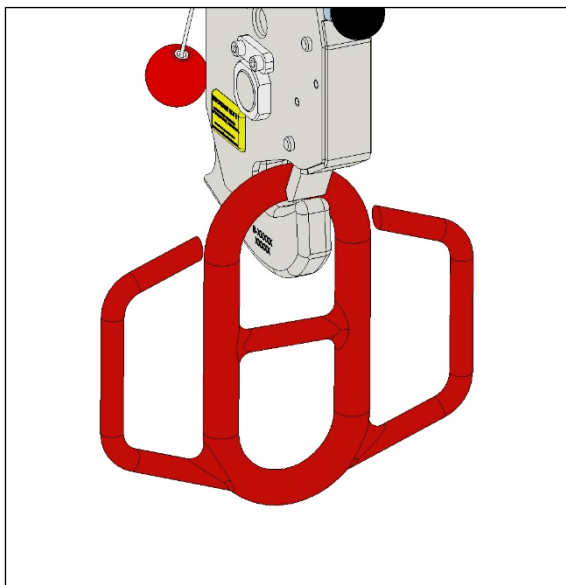



## HCH(T)

### ACTIVATION WIRE REPLACEMENT (HCHT 3,5 / HCHT 6,5 / HCHT 10)

- 1 Set the hook in closed position and lay the hook on the side.
- 2 Remove the screw from the latch to loosen the wire. The screw is secured with Loctite 243. Be careful not to trigger the hook.



- 3 Make sure that the activation wire is not attached to the latch and pull it out.
- 4 Clean the threads on the screw and the hole of the latch - first mechanically if necessary -, and with Loctite 7063. Allow the solvent to evaporate before assembly.



## HCH(T)

- 5** Insert the new activation wire into the hook through the opening on the side over the entrance pulley (or under the entrance pulley in case the activation cable shall point upwards, see the red arrow below).

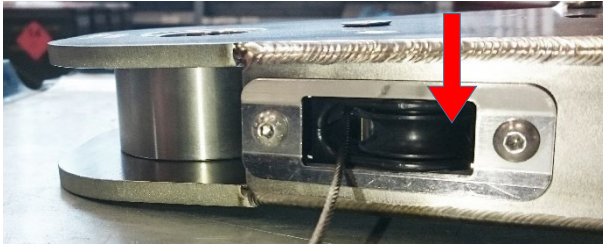

- 6** Guide the wire forward over the second pulley.

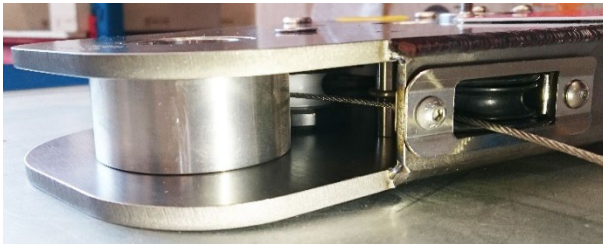

- 7** Bend the wire after the wheels and place the loop on the end of the wire inside the gap of the latch. Apply Loctite 243 onto the screw and lock the loop of the wire to the latch by hand force.

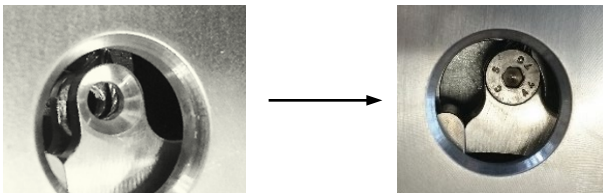

- 8** Do a functional test.



## HCH(T)

- 1 For safety reasons carry out the control in good lighting conditions.
- 2 Remove all impurities (salt, grease, dust, etc.) with fresh water. Remove ice if necessary.
- 3 Check that the following parts are free from deformations and defects:

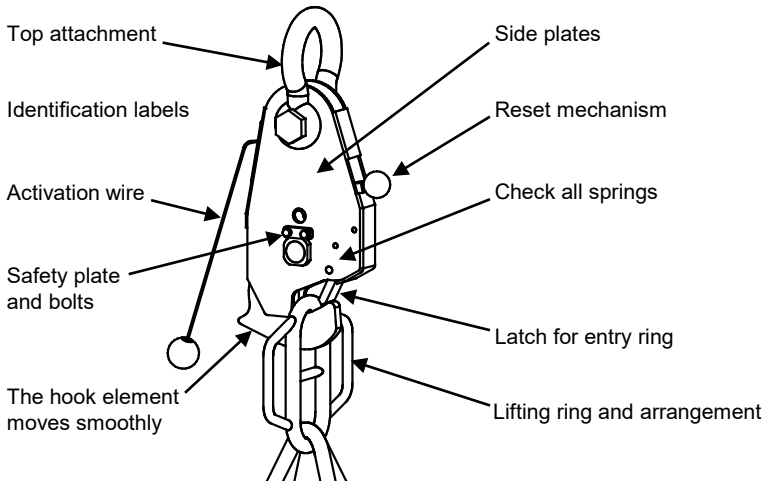
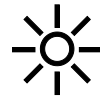

- 4 Do a functional test of the following :
  - The hook element can open fully.
  - The ring shall be inserted simply and safely.
  - The activation mechanism operates as expected.

### 5 DO NOT PAINT ANY PART OF THE HOOK!

Contact the manufacturer in case of any deviation!





## HCH(T)

### SAFE LAUNCH

**1** The hook operator connects the lifting ring and the painter line before launch, and then gives a signal to the crane operator that the lowering process can start.

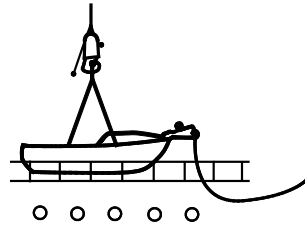

**2** The crane operator starts the lowering process with a continuous motion.

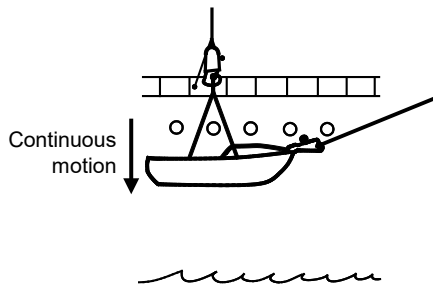

**3** The operators make sure that there are no obstacles under the boat.

The hook operator then activates the crane hook when the boat is close to the water surface.

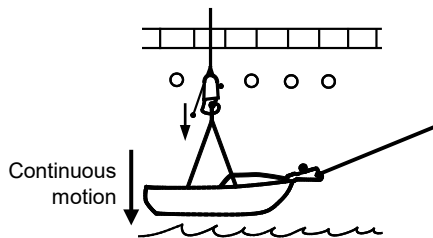

**4** The hook operator stands back and takes a safe stand-by position.

S  
A  
F  
E  
  
U  
S  
E



## HCH(T)

### SAFE LAUNCH

- 5** When the boat gets waterborne and the crane hook is off-loaded, the hook will open automatically and release the lifting ring.

The crane operator lifts the crane hook to avoid collision with the boat or the crew.

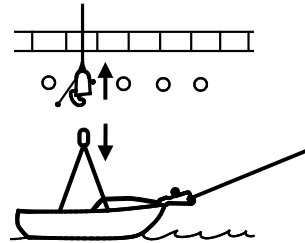

- 6** The coxswain or the hook operator releases the painter line when the boat and the crew are ready.

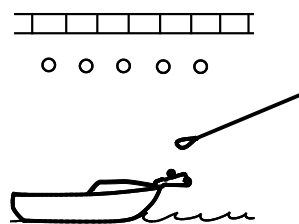

- 7** The coxswain maneuvers the boat ahead and away from the vessel.

S  
A  
F  
E  
  
U  
S  
E



## HCH(T)

### SAFE RECOVERY

**1** The vessel crew make sure that the crane hook is reset and securely attached to the crane wire.  
The hook operator makes sure that the lifting arrangement on the boat is ready and that the painter hook is reset.

**2** The coxswain maneuvers the boat close to the vessel to let the hook operator safely get the painter line.

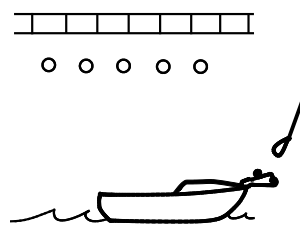

**3** The hook operator connects the painter line. The coxswain aligns the direction of the boat to the direction of the vessel.

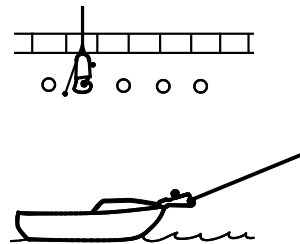

**4** The coxswain reduces the speed of the boat and the painter line is tensioned. The coxswain then makes sure to keep the correct direction of the boat and tension in the painter line.

The boat shall then be in the correct position below the crane hook.

**5** The crane operator lowers the crane hook to let the hook operator safely get it.

The hook operator gives a signal to the crane operator when the crane hook is in the correct operational position.

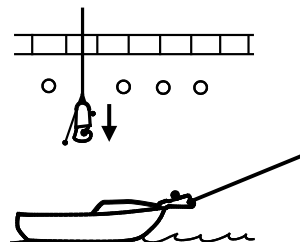

S  
A  
F  
E  
  
U  
S  
E



## HCH(T)

### SAFE RECOVERY

**6** The hook operator connects the lifting ring and gives a signal to the crane operator.

The crane operator starts the automatic tensioning system (if available) to give tension in the wire.

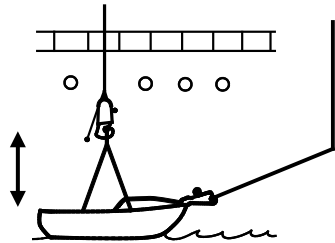

**7** The hook operator stands back and takes a safe stand-by position.

**8** The crane operator starts the lifting process with a smooth motion as the boat moves upwards on a wave.

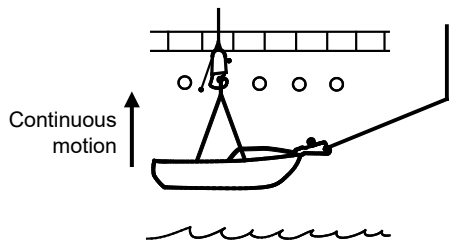

**9** The crane operator completes the lifting process with a continuous motion and places the boat into the crib.

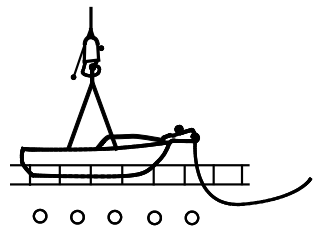

S  
A  
F  
E  
  
U  
S  
E